

PROFILE NF 200RGBW-F

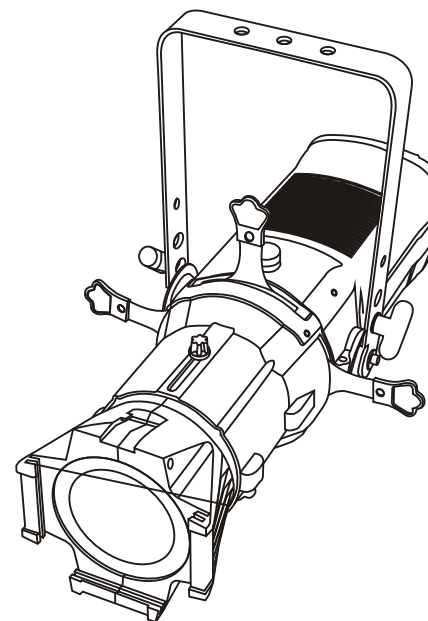

CE F \oplus IP20 LED $\left[\text{---}0.2\text{m} \right]$ $t_a 40^\circ\text{C}$ $t_c 100^\circ\text{C}$

User Manual

KEEP THIS MANUAL FOR FUTURE NEEDS

1 SAFETY INSTRUCTIONS



CAUTION

Becareful with your operations. With a dangerous voltage you can suffer a dangerous electric shock when touching wires!

This device has left the factory in perfect condition. In order to maintain this condition and to ensure a safe operation, it is absolutely necessary for the user to follow the safety instructions and warning notes written in this user manual.



IMPORTANT

Damages caused by the disregard of this user manual are not subject to warranty. The dealer will not accept liability for any resulting defects or problems.

If the device has been exposed to temperature changes due to environmental changes, do not switch it on immediately. The arising condensation could damage the device. Leave the device switched off until it has reached room temperature.

This device falls under protection-class I. Therefore it is essential that the device be earthed.

The electric connection must carry out by qualified person.

The device shall only be used with rate voltage and frequency.

Make sure that the available voltage is not higher than stated at the end of this manual.

Make sure the power cord is never crimped or damaged by sharp edges. If this would be the case, replacement of the cable must be done by an authorized dealer.

Always disconnect from the mains, when the device is not in use or before cleaning it. Only handle the power cord by the plug. Never pull out the plug by tugging the power cord.

During initial start-up some smoke or smell may arise. This is a normal process and does not necessarily mean that the device is defective, it should decrease gradually.

Please don't project the beam onto combustible substances.

Fixtures cannot be installed on combustible substances, keep more than 50cm distance with wall for smooth air flow, so there should be no shelter for fans and ventilation for heat radiation.

If the external flexible cable or cord of this luminaire is damaged, it shall be exclusively replaced by the manufacturer or his service agent or a similar qualified person in order to avoid a hazard.

9 MAINTENANCE AND CLEANING

The following points have to be considered during the inspection:

- 1) All screws for installing the devices or parts of the device have to be tightly connected and must not be corroded.
- 2) There must not be any deformations on the housing, color lenses, fixations and installation spots (ceiling, suspension, trussing).
- 3) Mechanically moved parts must not show any traces of wearing and must not rotate with unbalances.
- 4) The electric power supply cables must not show any damage, material fatigue or sediments.

Further instructions depending on the installation spot and usage have to be adhered by a skilled installer and any safety problems have to be removed.



CAUTION

Disconnect from mains before starting maintenance operation.



In order to make the lights in good condition and extend the life time, we suggest a regular cleaning to the lights.

- 1) Clean the inside and outside lens each week to avoid the weakness of the lights due to accumulation of dust.
- 2) Clean the fan each week.
- 3) A detailed electric check by approved electrical engineer each three month, make sure that the circuit contacts are in good condition, prevent the poor contact of circuit from overheating.

We recommend a frequent cleaning of the device. Please use a moist, lint-free cloth. Never use alcohol or solvents.

There are no serviceable parts inside the device. Please refer to the instructions under "Installation instructions".

Should you need any spare parts, please order genuine parts from your local dealer.

8 DMX CHANNELS

8CH Mode

Channel	Function	Value	Description
1	Dimmer	0-255	Dimmer
2	Color wheel	0-255	color1(red)
3		0-255	color2(green)
4		0-255	color3(blue)
5		0-255	color4(white)
6	tempera ture	0-30	no effect
		31-200	multi color change
		201-205	color temperature1(3200K)
		color temperature 2~10(each 5 data is a color temperature level)
		250-255	color temperature11(10000K)
7	strobe	0-10	no strobe
		11-255	speed of strobe (255 is the fastest)
8	Dimmer speed/ program	0-20	speed of dimmer 4 (the slowest and softest)
		21-40	speed of dimmer 3
		41-60	speed of dimmer 2
		61-80	speed of dimmer 1
		81-99	speed of dimmer off (fastest and no any delay)
		100-109	inner program1
		each 10 data is a program
		190-199	inner program10
		200-240	change color by sound control
		241-255	strobe by sound control

4CH Mode

Channel	Function	Value	Description
1	Color wheel	0-255	color1(red)
2		0-255	color2(green)
3		0-255	color3(blue)
4		0-255	color4(white)

2 UNPACKING

Thank you for choosing our PROFILE NF 200RGBW-F. For your own safety, please read this manual before installing the device. This manual covers the important information on installation and applications. Please install and operate the fixture with following instructions. Meanwhile, please keep this manual well for future needs.

The PROFILE NF 200RGBW-F is made of a new type of high temperature strength of cast aluminum casing with nice outlook. The fixture is designed and manufactured strictly following CE standards, complying with international standard DMX512 protocol. It's available independently controlled and linkable with each other for operation. And it is applicable for large-scale live performances, theater, studio, nightclubs and discos.

The PROFILE NF 200RGBW-F adopts 1PCS 200W 4IN1 COB LEDs (RGBW) which features high brightness and stability. Please carefully unpack it when you receive the fixture and check whether it is damaged during the transportation. And please check whether the following items are included inside the box:

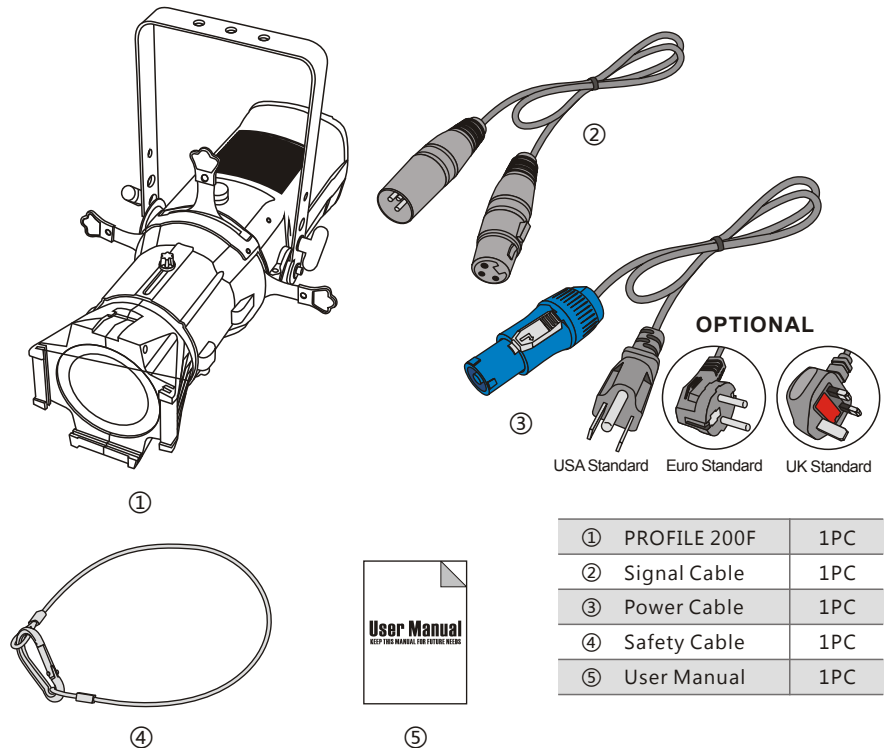

①	PROFILE 200F	1PC
②	Signal Cable	1PC
③	Power Cable	1PC
④	Safety Cable	1PC
⑤	User Manual	1PC

3 FEATURES & SPECIFICATIONS

Features

- 1*200W COB LEDs (RGBW)
- 50,000 hours life span and low power consumption
- Color Rendering Index(CRI): Ra≥95
- Optimized high definition optical system for improved photometric performance and field uniformity
- Projector-quality, high contrast aspheric lens
- Glass reflector that removes greater than 90% infrared radiation (heat) and reflects greater than 95% of visible light
- Lens tube interchangeable with filed angles available for 5°/10°/19°/26°/36°
- Flat and even spot image
- Smooth manual focus system
- Beam edge continually adjustable hard-to-soft
- Housing made by high intension fireproof black ABS
- Thermally insulated rear handle
- Thermally insulated knobs and single aluminum handle for installing
- 3 Metal spot cutting slots
- Barn door included
- Glass/Metal gobo slot as optional
- Color frame as optional
- Manual IRIS system as optional
- 0-100% Smooth and precise linear dimmer
- 25T/sec high speed shutter/strobe effect with variable speed
- Preset variable/random strobe and dimming pulse effect
- 4/8 DMX channels USITT DMX-512
- DMX512, master-slave, and sound control or auto operation
- 4-Button LCD display
- POWRECON connector IN/OUT
- 3-Pin XLR connectors IN/OUT
- Low noise fan integrated with copper liquid cooling system
- -35~45°C Max ambient temperature
- IP20 protection rating
- 1*Safety attachment point

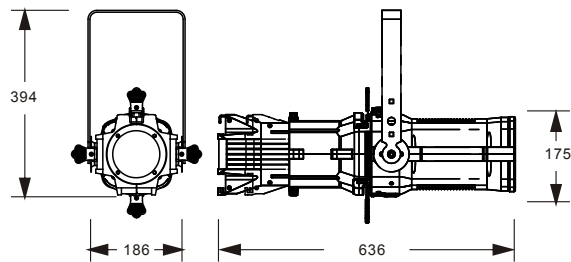

.03.

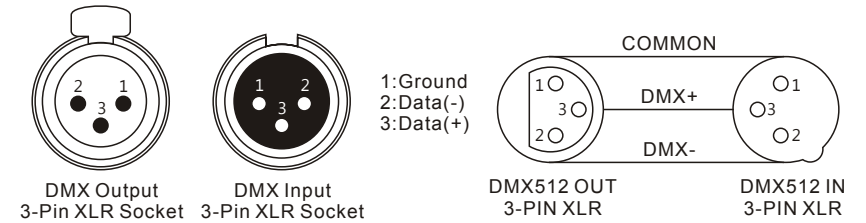

For installations where the DMX cable has to run a long distance or is in an electrically noisy environment, such as in a discotheque, it is recommended to use a DMX terminator. This helps in preventing corruption of the digital control signal by electrical noise. The DMX terminator is simply an XLR plug with a 120 Ω resistor connected between pins 2 and 3, which is then plugged into the output XLR socket of the last fixture in the chain. Please see illustrations below.

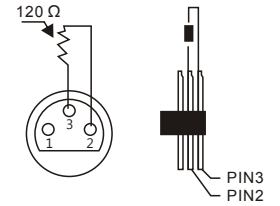

7 MENU OPERATIONS

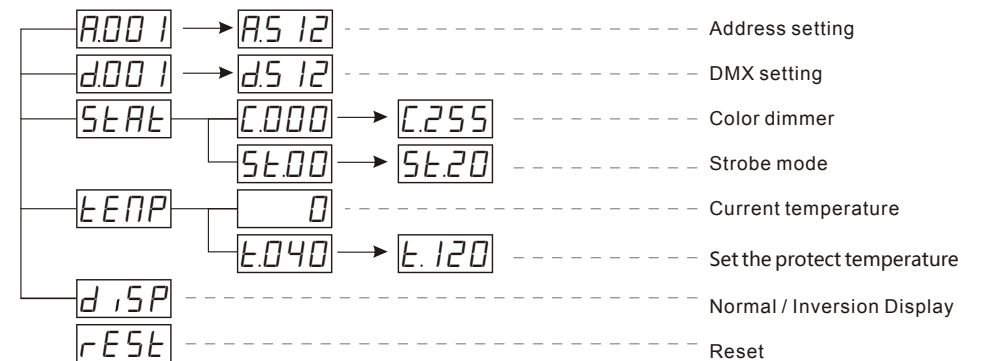

.08.

Regardless of the rigging option you choose for your PROFILE NF 200RGBW-F, always be sure to secure your fixture with a safety cable. The fixture provides a built-in rigging point for a safety cable on the hanging bracket as illustrated above. Be sure to only use the designated rigging point for the safety cable and never secure a safety cable to a carrying handle.

6 DMX-512 CONTROL CONNECTIONS

Connect the provided XLR cable to the female 3-pin XLR output of your controller and the other side to the male 3-pin XLR input of the moving head. You can chain multiple

Moving head together through serial linking. The cable needed should be two core, screened cable with XLR input and output connectors. Please refer to the diagram below.

DMX-512 connection with DMX terminator

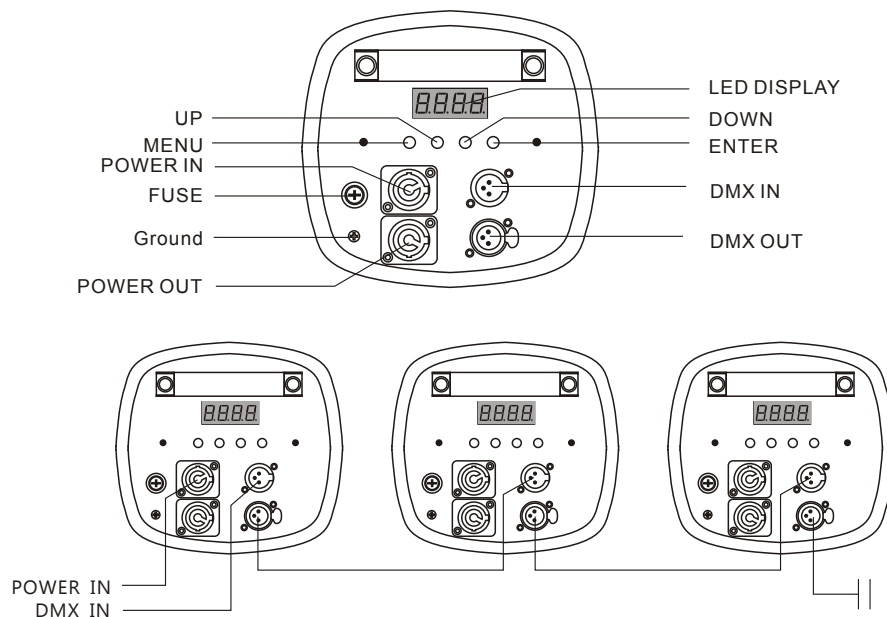

Specifications

Input Voltage: AC90-260V 50/60Hz

LED Quantities: 1*200W COB LEDs (RGBW)

Control Signal: DMX512, master-slave and sound activated or auto operation

Control Channel: 4/8 DMX channels USITT DMX-512

Power Consumption: 390W

Dimensions: 636(D)*186(W)*394(H)mm

Packing List: 325(D)*680(W)*330(H)mm

Net Weight: 6.25kg

Gross Weight: 8kg

4 PHOTOMETRIC DATA

Photometric Beam Angle Data $FC = LUX * 0.0929$

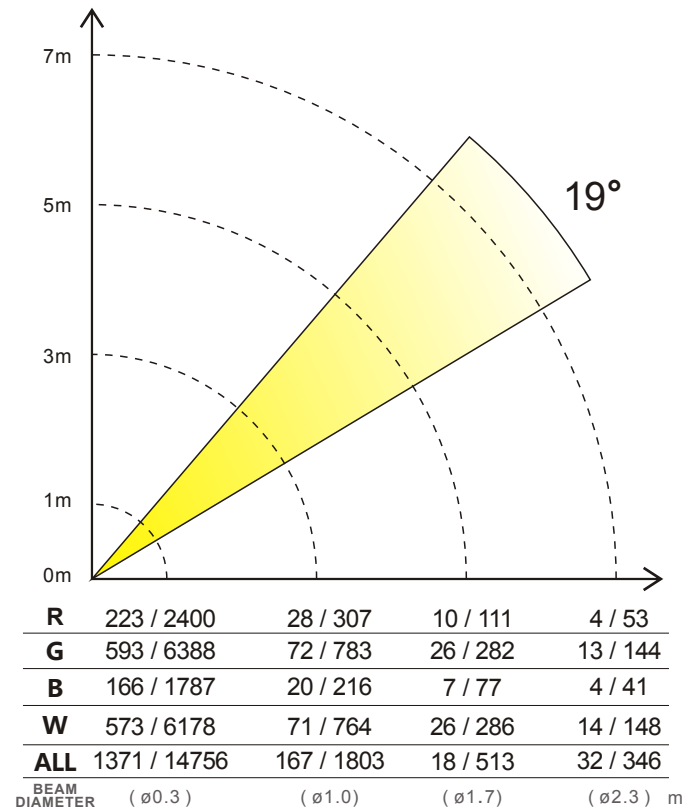

4 OPERATION INSTRUCTIONS

- The PROFILE NF 200RGBW-F is an LED wash light for on-site decoration purpose.
- Don't turn on the fixture if it's been through severe temperature difference like after transportation because it might damage the light due to the environment changes. So make sure to operate the fixture until it is in normal temperature.
- This light should be keep away from strong shaking during any transportation or movement.
- Don't pull up the light by only the head, or it might cause damages to the mechanical parts.
- Don't expose the fixture in overheat, moisture or environment with too much dust when installing it. And don't lay any power cables on the floor. Or it might cause electronic shock to the people.
- Make sure the installation place is in good safety condition before installing the fixture.
- Make sure to put the safety chain and check whether the screws are screwed properly when installing the fixture.
- Make sure the lens are in good condition. It's recommended to replace the units if there are any damages or severe scratch.
- Make sure the fixture is operated by qualified personnel who knows the fixture before using.
- Keep the original packages if any second shipment is needed.
- Don't try to change the fixtures without any instruction by the manufacturer or the appointed repairing agencies.
- It is not in warranty range if there are any malfunctions from not following the user manual to operate or any illegal operation, like shock short circuit, electronic shock, lamp broke, etc.

5 INSTALLATIONS

Cautions: For added protection mount the fixtures in areas outside walking paths, seating areas, or in areas were the fixture might be reached by unauthorized personnel.

Before mounting the fixture to any surface, make sure that the installation area can hold a minimum point load of 10 times the device's weight.

Fixture installation must always be secured with a secondary safety attachment, such as an appropriate safety cable.

Never stand directly below the device when mounting, removing, or servicing the fixture.

from a ceiling, or set on a flat level surface (see illustration below). Be sure this fixture is kept at least 0.5m (1.5 ft) away from any flammable materials (decoration etc.).

Always use and install the supplied safety cable as a safety measure to prevent accidental damage and/or injury in the event the clamp fails.

Mounting points: Overhead mounting requires extensive experience, including amongst others calculating working load limits, a fine knowledge of the installation material being used, and periodic safety inspection of all installation material and the fixture. If you lack these qualifications, do not attempt the installation yourself. Improper installation can result in bodily injury.

Be sure to complete all rigging and installation procedures before connecting the main power cord to the appropriate wall outlet.

Clamp Mounting: The PROFILE NF 200RGBW-F provides a unique mounting bracket assembly, and the safety cable rigging point in one unit (see the illustration below). When mounting this fixture to truss be sure to secure an appropriately rated clamp to the handle using a M10 screw fitted through the center hole of the handle. As an added safety measure be sure to attached at least one properly rated safety cable to the fixture using on of the safety cable rigging point.

